

1
2
3
4
5
6
7
8
9
10
11
12
13
14
15
16
17
18
19
20
21
22
23
24
25
26
27
28
29
30
31
32
33
34
35
36
37
38
39
40
41
42
43
44
45

TO: Maurits-Jan Prinz
CC: Marco Camboni
CC: Craig Hawthorne

DG Enterprise and Industry
Chemicals industry unit (F.2)
European Commission
ENTR/F.2, Maurits-Jan Prinz, BREY 11/219
B-1049 Brussels

Opinion / Public consultation on transparency measures for nanomaterials on the market

First of all, a lot of thanks to DG Enterprise and Industry (European Commission) for organising this important consultation.

This opinion represents an opinion of an individual citizen, not any legal entity.

This opinion does not contain:
– any business secrets
– any trade secrets
– any confidential information.

This opinion is public.
DG Enterprise and Industry can add the PDF file of this opinion to a relevant web page.

Annex 1 holds information about previously constructed opinions related to different consultations.
Annex 2 holds information about disclaimers and copyright.

Best Regards,

Jukka S. Rannila
citizen of Finland
signed electronically

[Continues on the next page]

46

47 **1. Amount of the background material**

48

49 Consultation ¹ web page links to several documents (PDF). I have not read all documents, and
50 therefore this opinion concentrates ***ONLY*** on the possible European Register of Products Containing
51 Nanomaterials.

52

53 **2. European Register of Products Containing Nanomaterials**

54

55 European Register of Products Containing Nanomaterials is an interesting case, and the creation of
56 a register should be assessed carefully.

57

58 **3. Similarity to the previous opinions:**

59

* **Creation of new European registers**

60

* **Cooperation between member state systems**

61

62 Annex 1 contains opinions based on earlier consultations.

63

64 Based on the previous opinions can be concluded, that there are several efforts to create new
65 European-wide register **OR** to create some cooperation between current member state systems.

66

67 Possibly previous opinions could be useful for evaluating some proposals.

68

69 **4. Some contributions from the previous consultations?**

70

71 One of the main contributions from the previous consultations has been simplified descriptions of
72 information technology. In many consultation documents, there has been quite ambiguous
73 descriptions about information technology in different application fields.

74

75 One simple conception of information technology solutions is the following figure.

76

77 The figure gives us four basic functions: add, retrieve, change and remove. Then there are databases
78 and documents used in different systems. Users use different displays (interfaces). Different
79 systems need administration (also maintenance) for keeping a system functional. Then there is
80 communication (also standards) for direct and indirect usage of an information system.

81

82 [Continues on the next page]

83

1 http://ec.europa.eu/enterprise/sectors/chemicals/reach/nanomaterials/public-consultation_en.htm, link worked on 8 July 2014

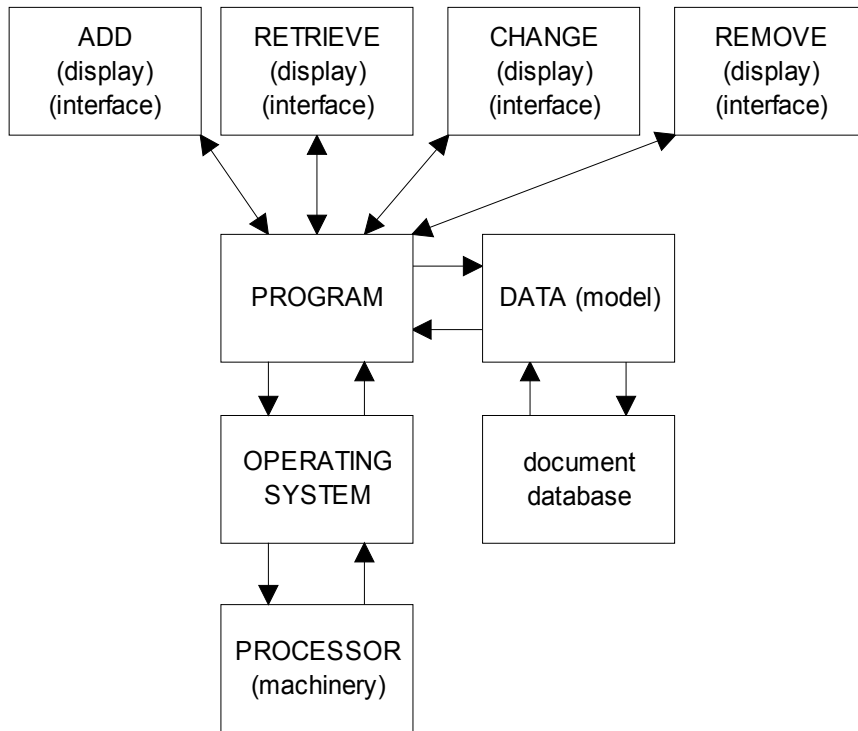

84
85
86
87
88
89

The mentioned linkages linkages between ownership, agreements and membership can also be divided to two actions: distribution and usage. There is nothing new on the previous explanations. However, the difference between distribution and usage should be as clear as possible.

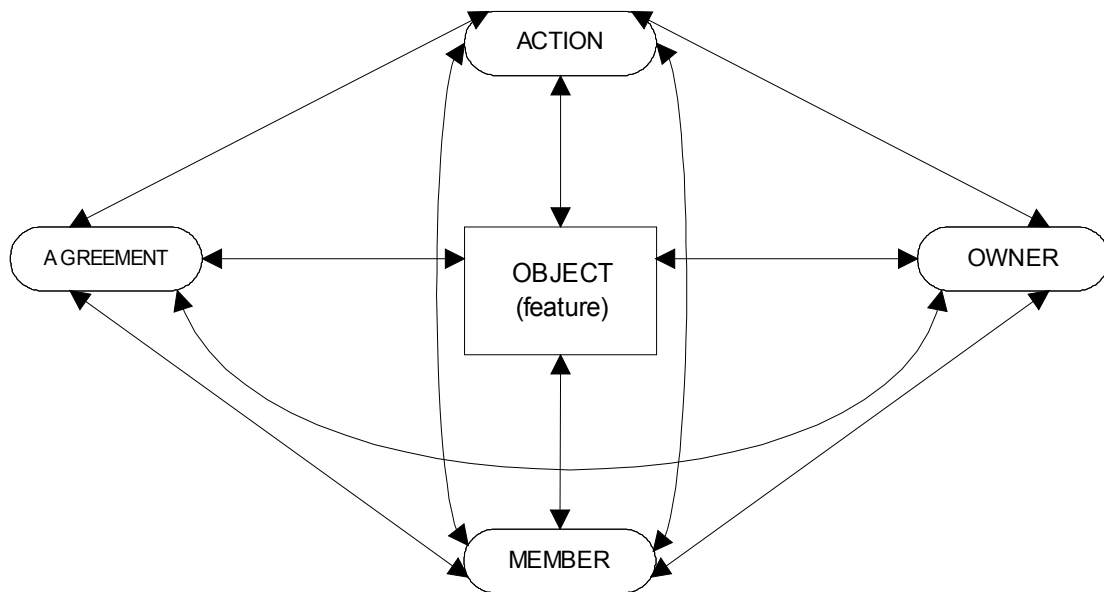

90
91
92

93 In short:

- 94 * the world is full of different objects (things)
- 95 * objects can be nowadays be digital in all phases
- 96 * someone owns some objects
- 97 * usage can be based on ownership, agreements and membership
- 98 * the linkages between ownership, agreements and membership can be very complex
- 99 * the linkages between ownership, agreements and membership can change very often.

100

101 Next table gives us some possibilities for assessing possibilities for open solutions and closed
102 solutions.

103

	Owner? Member? Agreement?	OPEN	CLOSED
1. Device / Machinery			
2. Operating system			
3. Program(s)			
4. Data models / Conceptual models		THIS consultation ?	
5. Documents			
6. Databases			
7. Communications			
8. Retrieve / Interface / Display			
9. Add / Interface / Display			
10. Remove / Interface / Display			
11. Change / Interface / Display			

104

105 It can be said, that this consultation is rather general, and there are possibilities for assessing
106 different combinations of different features for nanomaterial register(s).

107

108 In the previous consultations I have advocated following solution as the maximum solution:

- 109 * public sector institute owns the machinery and processor of the information system
- 110 * the machinery and processor are based on relevant open standards
- 111 * the operating system is based on an open-source solution
- 112 * public sector institute owns the source code of the information system
- 113 * public sector institute owns the database of the information system
- 114 * the database is based on open-source solution and on relevant open standards
- 115 * public sector institute owns all data in the information system.

116

117 Naturally, there can be solutions, which are not based on the maximum solution.

118

119 **Proposal 1: The European Commission (DG Enterprise and Industry) could organise**
120 **more technical consultation(s) about the possible European Register of Products**
121 **Containing Nanomaterials.**

122

123 **Note 1: The relations between different aspects of information systems can result**
124 **rather complicated network(s): i.e. Ownership, Membership, Agreement.**

125

126 **Note 2: e.g. Agency for the Cooperation of Energy Regulators (ACER) has organised**
127 **more (technical) consultations about different identifiers (IDs) and database structures.**

128

129 **5. Actual reality / Different standards and standards versions**

130

131 Previously I have advocated open standards for different information systems.

132

133 It is quite normal situation in the information technology field that there is competing standards for
134 some application field. Therefore there are all the time ongoing “standards wars” or “format wars”.
135 The information technology standards tend to be interrelated and one “standards war” or “format
136 war” can lead to another similar situation.

137

138 Therefore, there should be serious vigilance when assessing different standards and “standards” in
139 some application fields.

140

141 In the previous consultations the European Commission (DG Competition) has organised Market
142 Tests based on commitments provided by different companies, e.g. Microsoft, IBM, Reuters and
143 VISA. In some cases there has been a (near) monopoly situation, and in some cases different
144 standards has been (so called) de facto standards. Usage of some de facto standards demand e.g.
145 licence fees or other monetary requests. European Commission (DG Competition) has been active
146 to assess the monopoly/antitrust aspects of some de facto standards.

147

148 **Proposal 2: European Commission (DG Enterprise and Industry) could gather**
149 **information about current standards used in national registers (nanomaterials).**

150

151 Previously I have advocated open standards, even though in some cases open standards are not de
152 facto standards. In practice public sector has very important role, when some standards are
153 competing in the market place. Because public sector has a considerable buying power due to its
154 purchasing (power), and therefore public sector can sometimes direct markets to certain standards.

155

156 However, creating a new standard means actual both administrative and technical work, and in
157 some cases creating a new standard can last quite long. There are a lot of different standard setting
158 organisations (SDO), and one comprehensive list is provided ² for us by ConsortiumInfo.org.

159

160

2 <http://www.consortiuminfo.org/links/linksall.php>, Standard Setting Organizations and Standards List

161 **Proposal 3: The European Commission (DG Enterprise and Industry) could assess**
 162 **current standardisation efforts of different standard setting organisations (SDOs)**
 163 **related to nanomaterial issues.**

164

165 **6. Supporting and/or developing different standard types**

166

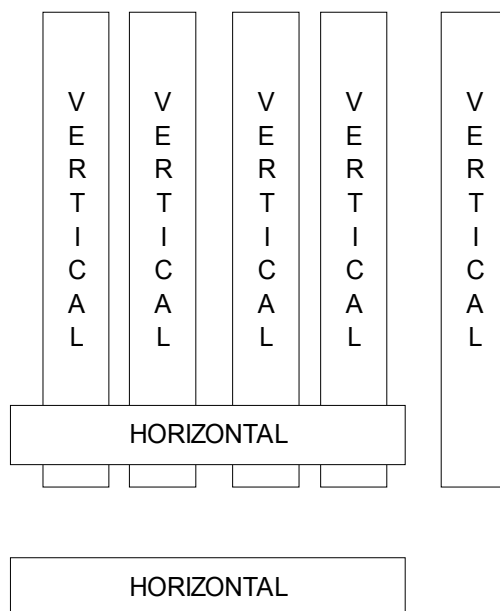

167

168

169 One of the main themes can be division standards: horizontal standards and vertical standards. What
 170 this means? Generally speaking, different ICT solutions will implement a large collection of
 171 different standards: open standards and closed standards. In many cases, different ICT solutions do
 172 not work together and this might not constitute a problem. However, in many cases different ICT
 173 solutions has to work together seamlessly – possibly without further problems.

174

175 **Proposal 4: There could be separation of horizontal standards and vertical standards.**

176 **Proposal 5: There could be different standardisation efforts to horizontal standards**
 177 **and vertical standards.**

178

179 **Proposal 6: Developing (and possible funding of development) horizontal standards**
 180 **should favoured in the development of new and/or revised standards.**

181

182 An example can be different email standards. There are numerous email systems developed with
 183 numerous technologies (vertical), but the cooperation between numerous email systems is possible
 184 with different (horizontal) email standards.

185

186 **Note 3: The number of redundant standardisation efforts should be minimal.**

187

188

189 **7. Standardisation of interfaces for different stakeholders (companies, customers, etc.)**

190

191 In previous consultations I have advocated standardisation of interfaces. There are different
 192 processes (Beginning → Actions → Ending), which can be described in different levels of details.
 193

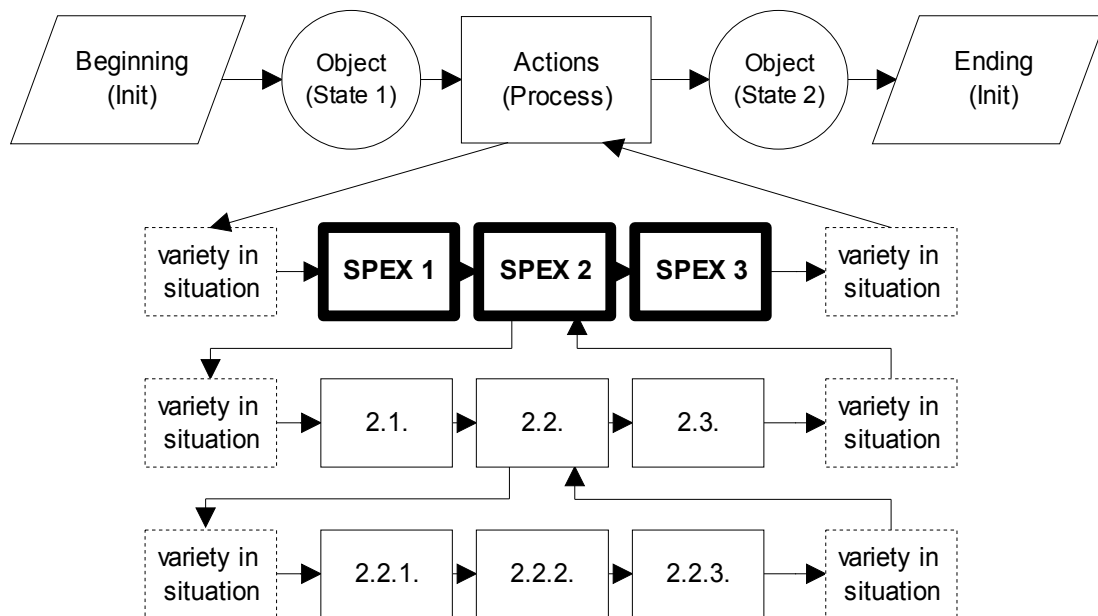

194

195

196 There can be highly detailed points in different processes (SPEX), which could be standardised.

197

198 **Proposal 7: There could be a project for modelling different processes.**

199

200 **Proposal 8: Some parts of the processes could be standardised for interfaces (SPEX)**
 201 **for different stakeholders.**

202

203 **Proposal 9: Some standardised customer interfaces (SPEX) could be used for having**
 204 **better service processes for different stakeholders.**

205

206 It can be noted, that different actors can naturally have other non-standardised interfaces for
 207 different processes, and there is nothing wrong with that approach. Also, we have to assess the need
 208 for several interfaces. In other words, different stakeholder groups need different interfaces.

209

210 In the previous consultations documents I have explicated the need for standardisation of some
 211 interfaces. In practical reality, there can be different information technology applications for the
 212 same operations. It could be feasible to create different standardised interfaces, which can be
 213 implemented with different technologies.

214

215 [Continues on the next page]

216

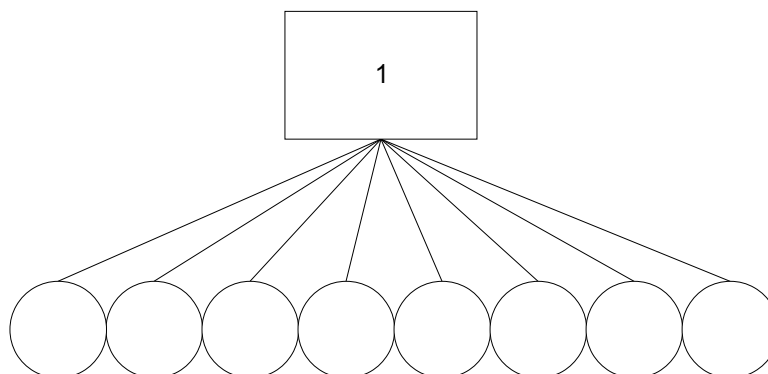

217
218

219

Proposal 10: There could be a project for analysing the quality and the quantity of different interfaces for different stakeholder groups.

220

221

222

Proposal 11: European Commission could advocate standardised user interfaces in different levels.

223

224

225

Naturally, there can be even tens of different user interfaces depending on the nature of different systems. The actual reality is very complex. In practical terms there are several situations:

226

227

* systems must communicate directly with each other

228

* there will be several communications methods for direct communication

229

* there are different standards for direct communication

230

* data in the system is added by processing different documents

231

* data from the system is extracted and loaded to different documents

232

* there are different standards for different documents

233

* there will be several types for different documents

234

* there are several displays / interfaces to system(s)

235

* there are several user groups.

236

237

The following figure tries to explicate these features of information systems.

238

239

One solution can be standardisation efforts for different interfaces in several systems. The European Commission could work with global and regional partners for creating standardised user interfaces for different stakeholders. These standardised user interfaces could then be implemented by different information systems.

240

241

242

243

244

Proposal 12: The Commission can could support work, which rigorously develops and tests different interfaces for different purposes.

245

246

247

In reality there can be some applications (e.g. A, B, C) for the same operations, and there can be different providers for the same solutions. IF every solution has a different interface, there can be a serious hindrance with the needed education for a new interface. When there are some standardised interfaces (SPEX), the efforts for learning of a new interface can be minimised.

248

249

250

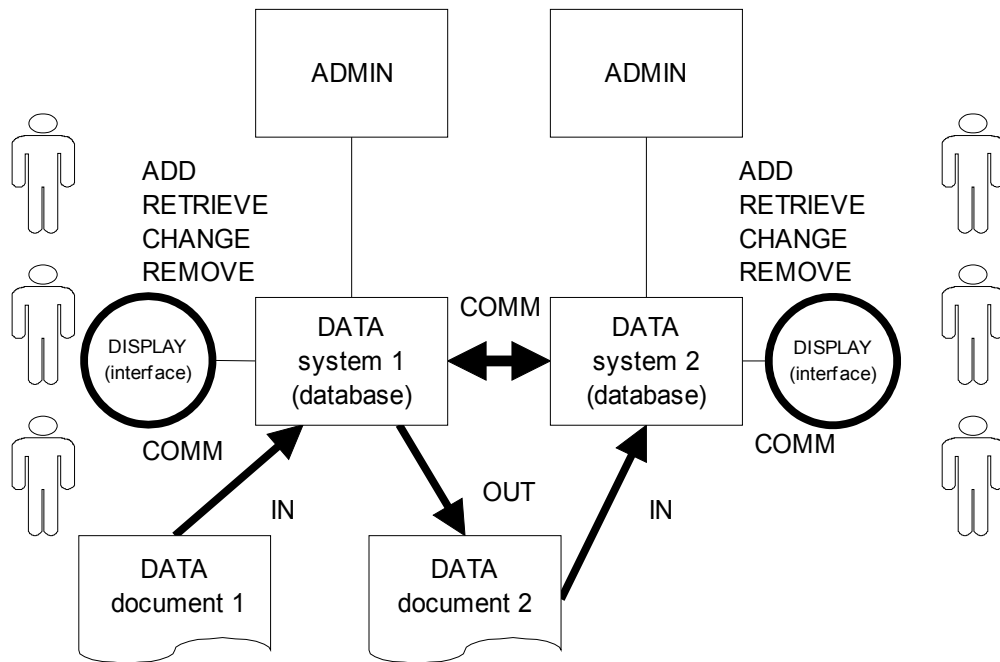

251
252
253
254

8. Layered systems

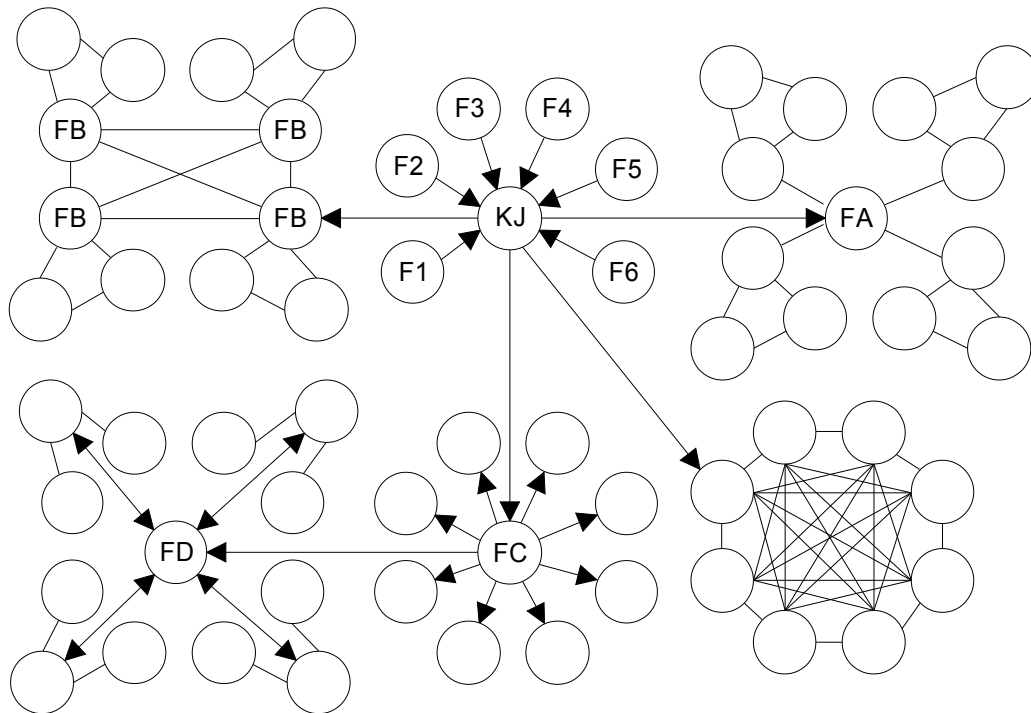

255
256
257
258

In some previous consultations I have presented the figure above. In practical reality, there are different systems, which use very different standards/formats for cooperation between different

259 systems.

260

261 **Repetition:** There are a lot of different standard setting organisations (SDO), and one
262 comprehensive list is provided ³ for us by ConsortiumInfo.org. Examples are naturally different
263 XML documents and CSV documents.

264

265 9. More and more new identifiers (ID)

266

267 In the previous consultations there has been discussion about different identifiers (ID) in the
268 different systems. It can be noted from the previous opinions, that there will be several and different
269 identifiers (ID) for different levels. In the European Union level, there can be several identifiers
270 (ID), e.g. following:

271

- 272 * global identifiers (ID)
- 273 * EU-wide identifiers (ID)
- 274 * general member state identifiers (ID)
- 275 * several identifiers (ID) in a member state.

276

277 It can be noted, that some member states (EU) are federations, and different federal states can have
278 their own identifiers (ID).

279

280 More IDs is one of the consequences of digitalisation (of everything). The ID is identifier in an
281 information system. Examples of these identifiers are following:

282

- 283 1) Facebook ID for an individual person
- 284 2) Facebook ID for the individual up-dates of individuals
- 285 3) Data Universal Numbering System (D-U-N-S)
- 286 4) Reuters instruments codes (RICs)
- 287 5) Social security code for individual citizens in the European Union member states
- 288 6) Business identity code for a company in an European Union member state
- 289 7) Value added tax code for a company in an European Union member state.

290

291 The examples of private IDs (Facebook IDs, Data Universal Numbering System (D-U-N-S),
292 Reuters Instrumens Codes (RICs)) show, that persons and/or communities can use or even demand
293 of using IDs from privately owned information systems.

294

295 Social security codes and tax identifier codes are examples of publicly owned information system,
296 and use of public identifiers have spread to several private systems. E.g. in Finland the social
297 security code is so prevalent, that the private companies can possibly combine information from
298 numerous private information systems. Naturally, these information combination efforts raise
299 serious questions about the rules and regulations of combining information from private
300 information systems.

301

302

3 <http://www.consortiuminfo.org/links/linksall.php>, Standard Setting Organizations and Standards List

303 **Proposal 13: There could be a systematic project to collect relevant information of**
 304 **different identifiers: e.g. global, EU-wide, regional and national.**

305
 306 When information about relevant identifiers is collected, there could be a serious assessment of
 307 possible (near) monopoly situation of some identifiers. Depending on the nature of an identifier,
 308 there may be a need for serious (anti-trust?) negotiations with providers of some identifiers.

309
 310 **Proposal 14: The Commission could assess nature of different identifiers.**

311 **Proposal 15: The Commission could start serious negotiations with some providers of**
 312 **identifiers.**

313

314 10. Avoiding redundant work

315

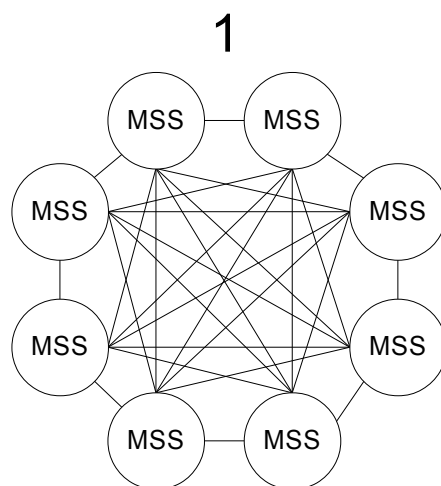

(MSS = a member state information system)

316

317

318

319 In member states (EU) there are hundreds of different information systems (MSS = as member
 320 state information system). It can be concluded, that these systems are layered in different ways and
 321 implement several standard (technology) generations. Generally speaking, there can be several
 322 many-to-many connections, which are very cumbersome to implement and maintain.

323

324 Generally speaking, in different members states (EU) there are unique situations and unique
 325 information systems, when creating cooperation between different copyright holder. These
 326 information system can be very specialised, and we can call them as Member State Systems (MSS).
 327 The other extreme would be, that there would be just only one system (MSS) in a member state
 328 system, and it could be connected to just one European contact point (EUCP).

329

330 In the European Union level there is need to extract information from different member state
 331 systems, and then there is a European contact point (EUCP) for this cooperation between different
 332 information systems.

333

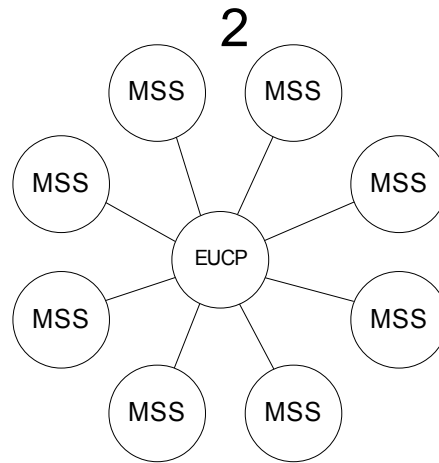

(MSS = a member state information system)
 (EUCP = European Contact point)

334
 335
 336
 337
 338
 339
 340
 341

The practical reality is, that there will be several systems (MSS) in different member states. Therefore, there should be Member State Contact Point (MSCP) and the European Contact point (EUCP). Then different member states can consolidate own information systems with the Member State Contact Point (MSCP).

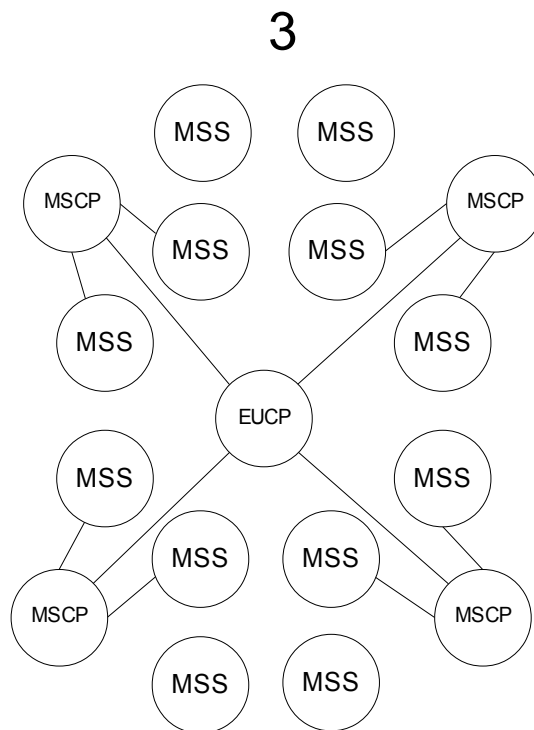

(MSS = a member state information system)
 (EUCP = European Contact point)
 (MSCP = Member State Contact Point)

342
 343
 344
 345

346
347 In previous consultations I have advocated of creating separate member state contact points
348 (MSCP) and a separate European Union contact point (EUCP). In this way it easier for member
349 state to consolidate different information system with their own timetable.

350
351 There can be Member State Contact Points (MSCP), which integrates member state systems
352 (MSSs), and this Member State Contact Point (MSCP) integrates to the European Contact Point
353 (EUCP). In reality there are a huge collection of different Member State Systems (MSSs), which are
354 constructed with wide variety of technologies.

355
356 **Proposal 16: The Commission should start implementing the proposed standards from**
357 **European Union contact point(s) (EUCP) to member state contact points (MSCP).**

358
359 Therefore, there should be Member State Contact Point (MSCP) and the European Contact point
360 (EUCP). Then different member states can consolidate own information systems with the Member
361 State Contact Point (MSCP).

362
363 **Proposals:**
364 **Proposal 17: There could be one European-wide contact point.**
365 **Proposal 18: There could be one European-wide identifier (ID).**
366 **Proposal 19: The European-wide identifier (ID) could refer to member state identifiers.**
367 **Proposal 20: Member states can consolidate own information systems**
368 **Proposal 21: Member states could have one contact point for European-wide**
369 **cooperation.**
370 **Proposal 22: Global issues could be assessed.**

371
372 Like said before, there can be several non-European identifiers (ID), and cooperation with global
373 IDs is one issue.

374 375 **11. Questionnaires for the members of different stakeholders (associations)**

376
377 One idea is distributing questionnaires for ⁴ different IT expert associations, and members of those
378 associations could assess different IT standard proposals. Nowadays a lot of questionnaires can be
379 distributed and answered using different electronic measures.

380
381 **Proposal 23: Part of the evaluation could be organising (electronic) questionnaires for**
382 **members of different stakeholder/expert associations based on the application field.**

383
384 The questionnaires can be very structured or very free-form. The advantage of very structured
385 questionnaire is naturally the ease of processing the results of an questionnaire. Answers to free-
386 form questionnaires can result a lot of documents, and their assessment can mean a lot of manual
387 processing.

388 389 **12. Example of standards / Different information feeds**

4 <http://www.ttlry.fi/english>, e.g. The Finnish Information Processing Association, FIPA, (Tietotekniikan liitto ry)

390

391 In the previous consultations I have used RSS feeds as an example.

392



393

394

395 To be precise, there are some standards for RSS feeds: RSS 2.0⁵ standard and Atom^{6 7} standards.

396 There are different systems, which comply with these example standards (RSS and Atom)

397 differently.

398

399 It can be said, that there is need for different information feeds between different systems. Like said

400 before, different actors can assess different existing standards in order to avoid redundant (even

401 useless) standardisation.

402

403 **13. Organising more technical consultations?**

404

405 **Proposal 24: DG Enterprise and Industry could organise more technically oriented**406 **consultations based on results of this consultations.**

407

408 **Proposal 25: Some possible issues for new consultations could be following:**

409

410 * **identifiers in different levels (Member state, EU-wide, global)**411 * **exact database structure of the European Register of Products Containing**412 **Nanomaterials**413 * **assessment of different standards**414 * **technical consultation about the usable technologies for the European Register**415 **of Products Containing Nanomaterials**

416

417

418

419 **14. Good luck !!!**

420

421 This opinion is quite limited. Hopefully, there are other constructive ideas presented in other

422 opinions. This remains to be seen.

423

424

425 [Continues on the next page]

426

5 <http://www.rssboard.org/rss-specification>.6 <http://tools.ietf.org/html/rfc4287>, The Atom Syndication Format7 <http://tools.ietf.org/html/rfc5023>, The Atom Publishing Protocol

427
428
429
430
431
432
433
434
435
436
437
438
439
440
441
442
443
444
445
446
447
448
449
450
451
452
453
454
455
456
457
458
459
460
461
462
463
464
465
466
467
468
469
470
471

ANNEX 1

My opinions to the previous and relevant consultations – there consultations were mostly organised by the Commission of the European Union. General page to all consultations – both in English and in Finnish: <http://www.jukkarannila.fi/lausunnot.html>

EN: Opinion 1: Review of the rules on access to documents

http://www.jukkarannila.fi/lausunnot.html#nro_1

EN: Opinion 2: Schools for the 21st Century

http://www.jukkarannila.fi/lausunnot.html#nro_2

EN: Opinion 3: The future of pharmaceuticals for Human use in Europe- making Europe a Hub for Safe and Innovative medicines

http://www.jukkarannila.fi/lausunnot.html#nro_3

EN: Opinion 5: Consumer Scoreboard, Questionnaire for stakeholders

http://www.jukkarannila.fi/lausunnot.html#nro_5

EN: Opinion 6: Consultation on a Code of Conduct for Interest Representatives

http://www.jukkarannila.fi/lausunnot.html#nro_6

EN: Opinion 8: European Interoperability Framework, version 2, draft

http://www.jukkarannila.fi/lausunnot.html#nro_8

EN: Opinion 9: CAMSS: Common Assessment Method for Standards and Specifications, CAMSS proposal for comments

http://www.jukkarannila.fi/lausunnot.html#nro_9

EN: Opinion 15: Collective Redress

http://www.jukkarannila.fi/lausunnot.html#nro_15

EN: Opinion 17: Opinion to Antitrust Case No. COMP/C-3/39.530

http://www.jukkarannila.fi/lausunnot.html#nro_17

EN: Opinion 18: Opinion Related to the Public Undertaking by Microsoft

http://www.jukkarannila.fi/lausunnot.html#nro_18

EN: Opinion 19: Official Acknowledgement by the Commission

http://www.jukkarannila.fi/lausunnot.html#nro_19

- 472 EN: Opinion 20: SECOND Opinion Related to the Public Undertaking by Microsoft
473 http://www.jukkarannila.fi/lausunnot.html#nro_20
474
- 475 EN: Opinion 21: Opinion about the European Interoperability Strategy proposal
476 http://www.jukkarannila.fi/lausunnot.html#nro_21
477
- 478 EN: Opinion 23: Public consultation on the review of the European Standardisation System
479 http://www.jukkarannila.fi/lausunnot.html#nro_23
480
- 481 EN: Opinion 27: Public Consultation on the Modernisation of EU Public Procurement Policy
482 http://www.jukkarannila.fi/lausunnot.html#nro_27
483
- 484 EN: Opinion 28: Consultation on the Europe 2020 Project Bond Initiative
485 http://www.jukkarannila.fi/lausunnot.html#nro_28
486
- 487 EN: Opinion 30: Internet Filtering
488 http://www.jukkarannila.fi/lausunnot.html#nro_30
489 NOTE: Organised by the European Committee for Standardization (CEN) ⁸
490
- 491 EN: Opinion 32: COMP/C-3/39.692/IBM – Maintenance services
492 http://www.jukkarannila.fi/lausunnot.html#nro_32
493
- 494 EN: Opinion 34: REMIT Registration Format
495 http://www.jukkarannila.fi/lausunnot.html#nro_34
496 NOTE: Organised by The Agency for the Cooperation of Energy Regulators (ACER) ⁹
497
- 498 EN: Opinion 35: Exploiting the employment potential of the personal and household services
499 http://www.jukkarannila.fi/lausunnot.html#nro_35
500
- 501 EN: Opinion 37: CASE COMP/39.654 - Reuters instrument codes
502 http://www.jukkarannila.fi/lausunnot.html#nro_37
503
- 504 EN: Opinion 39: Registry options to facilitate linking of emissions trading systems
505 http://www.jukkarannila.fi/lausunnot.html#nro_39
506
- 507 EN: Opinion 40: Media Freedom and Pluralism / audiovisual regulatory bodies
508 http://www.jukkarannila.fi/lausunnot.html#nro_40
509
- 510 EN: Opinion 41: AT.39398: observations on the proposed commitments
511 http://www.jukkarannila.fi/lausunnot.html#nro_41
512
- 513 EN: Opinion 42: Opening up Education
514 http://www.jukkarannila.fi/lausunnot.html#nro_42

⁸ <http://www.cen.eu/> (Accessed 2 July 2012)

⁹ <http://www.acer.europa.eu/> (Accessed 2 July 2012)

515

516 EN: Opinion 43: Publication of extracts of the European register of market participants

517 http://www.jukkarannila.fi/lausunnot.html#nro_43

518 NOTE: Organised by The Agency for the Cooperation of Energy Regulators (ACER)

519

520 EN: Opinion 44: Evaluation policy guidelines

521 http://www.jukkarannila.fi/lausunnot.html#nro_44

522

523 EN: Opinion 45: About ICT standardisation

524 http://www.jukkarannila.fi/lausunnot.html#nro_45

525

526 EN: Opinion 46: Review of the EU copyright rules

527 http://www.jukkarannila.fi/lausunnot.html#nro_46

528

529 EN: Opinion 51: European Area of Skills and Qualifications

530 http://www.jukkarannila.fi/lausunnot.html#nro_51

531

532 EN: Opinion 52: Trusted Cloud Europe Survey

533 http://www.jukkarannila.fi/lausunnot.html#nro_52

534

535 EN: Opinion 53: Trade Reporting User Manual (TRUM) (Draft)

536 http://www.jukkarannila.fi/lausunnot.html#nro_53

537 NOTE: Organised by The Agency for the Cooperation of Energy Regulators (ACER)

538

539 EN: Opinion 55: European Energy Regulation

540 http://www.jukkarannila.fi/lausunnot.html#nro_55

541 NOTE: Organised by The Agency for the Cooperation of Energy Regulators (ACER)

542

543 EN: Opinion 59: Green paper on mobile Health

544 http://www.jukkarannila.fi/lausunnot.html#nro_59

545

546 EN: Opinion 60: Cross-border inheritance tax problems within the EU

547 http://www.jukkarannila.fi/lausunnot.html#nro_60

548

549

550

551 My opinions to the previous and relevant consultations – there consultations were mostly organised

552 by the Commission of the European Union. General page to all consultations – both in English and

553 in Finnish: <http://www.jukkarannila.fi/lausunnot.html>

554

555

556 [Continues on the next page]

557

558

559 DISCLAIMERS

560

561 Legal disclaimer:

562 All opinions in this opinion paper are personal opinions and they do not represent opinions of any legal entity I am
563 member either by law or voluntarily. This opinion paper is only intended to trigger thinking and it is not legal advice.

564 This opinion paper does not apply to any past, current or future legal entity. This opinion paper will not cover any of the
565 future changes in this fast-developing area. Any actions made based on this opinion is solely responsibility of respective
566 actor making those actions.

567

568 Political disclaimer:

569 These opinions do not represent opinions of any political party. These opinions are not advices to certain policy and
570 they are only intended to trigger thinking. Any law proposal based on these opinions are sole responsibility of that legal
571 entity making law proposals.

572

573 These opinions are not meant to be extreme-right, moderate-right, extreme-centre¹⁰, moderate-centre, extreme-left or
574 moderate-left. They are only opinions of an individual whose overall thinking might or might not contain elements of
575 different sources. These opinions do not reflect past, current or future political situation in the Finnish, European or
576 worldwide politics.

577

578 These opinions are not meant to rally for a candidacy in any public election in any level.

579

580 Content of web pages:

581 This text may or may not refer to web pages. The content of those web pages is not responsibility of author of this
582 document. They are referenced on the date of this document. If referenced web pages are not found after the date when
583 this document is dated, that situation is not responsibility of the author. All changes done in the web pages this
584 document refers are sole responsibility of those organisations and individuals maintaining those web pages. All illegal
585 content found on the referred web pages is not on the responsibility of the author of this document, and producing that
586 kind content is not endorsed by the author of this document.

587

588 Use of broken English

589 This text is in English, but from a person, whose is not a native English-speaking person. Therefore the text may or may
590 not contain bad, odd and broken English, and can contain awkward linguistic solutions.

591

592 COPYRIGHT

593

594 This opinion paper is distributed under Creative Commons licence, to be specific the licence is "Attribution-
595 NonCommercial-NoDerivatives 4.0 International (CC BY-NC-ND 4.0)". The text of the licence can be obtained from
596 the following web page:

597 <http://creativecommons.org/licenses/by-nc-nd/4.0/>

598 The English explanation is on the following web page:

599 <http://creativecommons.org/licenses/by-nc-nd/4.0/legalcode>

600

601

602



10 Based on the Finnish three-party system there is a phenomenon called extreme-centre in Finland. The 2011 parliamentary elections in Finland challenge the three-party system, since three "old" parties were not traditionally as the three largest parties. The is now a "new" party as the third largest party. We all must remain being interested about this new development in Finland.